

Groovy Wall™ Light Box R-01

GW-LB-R-01

Groovy Wall™ fabric light boxes feature durable 100mm aluminum extrusion frames, push-fit back-lit fabric graphics and LED top and bottom lighting. Single and double-sided graphic options are available. LED lights come adhered to the frame, making set-up as simple as assembling the frame, applying the push-fit graphics and plugging in the electrical cord!

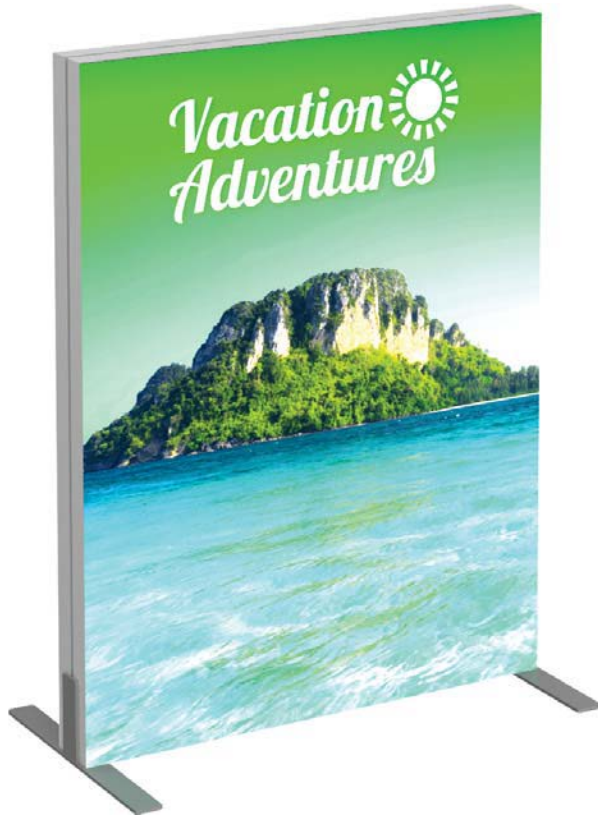

features and benefits:

- 100mm (4") silver extrusion frame
- Integrated LED lighting strips top & bottom
- Single or double-sided SEG dye-sublimated push-fit fabric graphics
- Easy assembly
- Comes packaged with one MCWC2 wheeled molded case for transport and storage
- Lifetime hardware warranty against manufacturer defects

dimensions:

Hardware	Graphic
<p>Assembled unit: 36.25" w x 47.5" h x 19.7" d 921 mm(w) x 1206 mm(h) x 500 mm(d)</p> <p>Approximate weight with case: 51 lbs / 22 kgs</p>	<p>Refer to related graphic template for more information.</p>
Shipping	additional information:
<p>Packing case(s): 1 MCWC2</p> <p>Shipping dimensions: MCWC2: Expandable case length (l) may vary 40" - 66" l x 18" w x 18" h 1016 mm-1677 mm(l) x 458 mm(w) x 458 mm(h)</p> <p>Approximate total shipping weight (includes cases & graphics): 53 lbs / 24 kgs</p>	<p>Graphic material: dye-sublimation fabric</p> <p>Power requirements: 24V / 3.0A / 72 watts per transformer One transformer per unit</p>

We are continually improving and modifying our product range and reserve the right to vary the specifications without prior notice. All dimensions and weights quoted are approximate and we accept no responsibility for variance. E&OE. See Graphic Templates for graphic bleed specifications.



2010 Hancock Street
San Diego, CA 92110
800.697.4670
info@beautifuldisplays.com

Included In Your Kit

Tools, Components, & Connectors



5MM ALLEN-T x1



CB9 x4

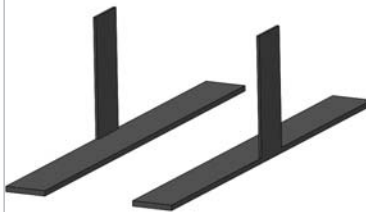

SW-FOOT-500-2 x1

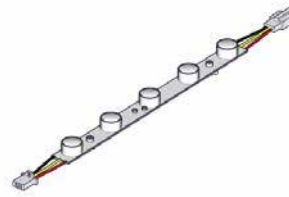

LED-WHT-DB-300 x4



LED-DB-CL-1100 x1

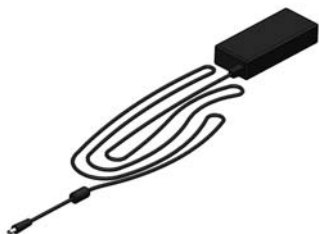

LED-DB-PWRSUPPLY x1



LED-DB-PWRCORD x1

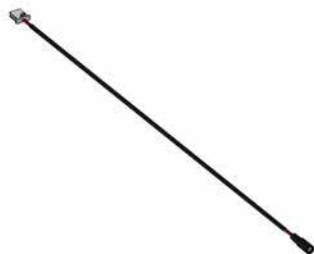

LED-DB-CL-DCJ-600 x1

Graphics



GB-LB-R-01-S-G x1



GB-LB-R-01-OP-LN x1

Included In Your Kit

Extrusions



WME-1000 x1



PHFC4-900-MCB9-MCB9 x2



PHFC4-1200-MCB9-MCB9 x1



PHFC4-1200-MCB9-MCB9-GR x1

Exploded View

GB-LB-R-01

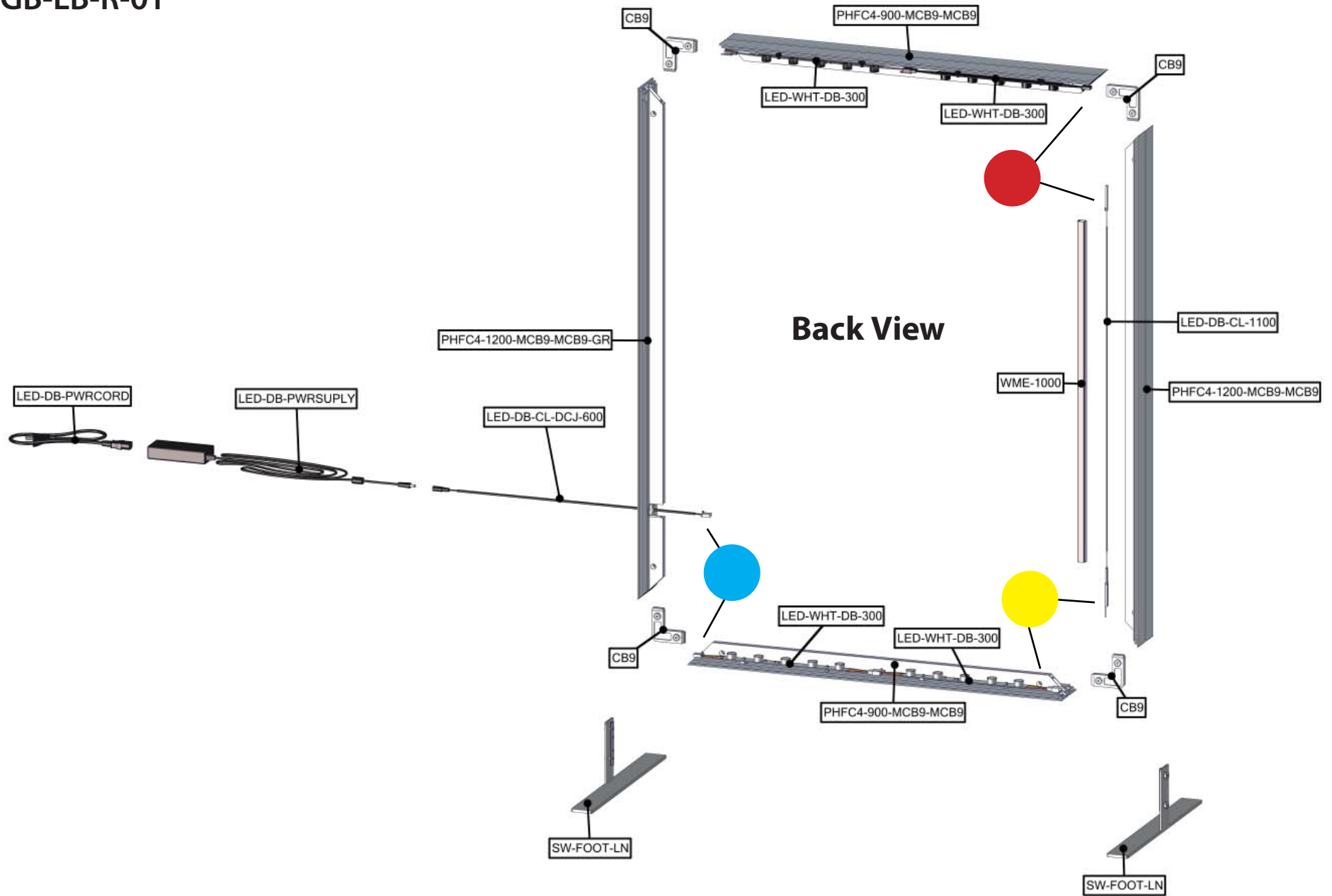

Internal Lighting Setup

GW-LB-R-01

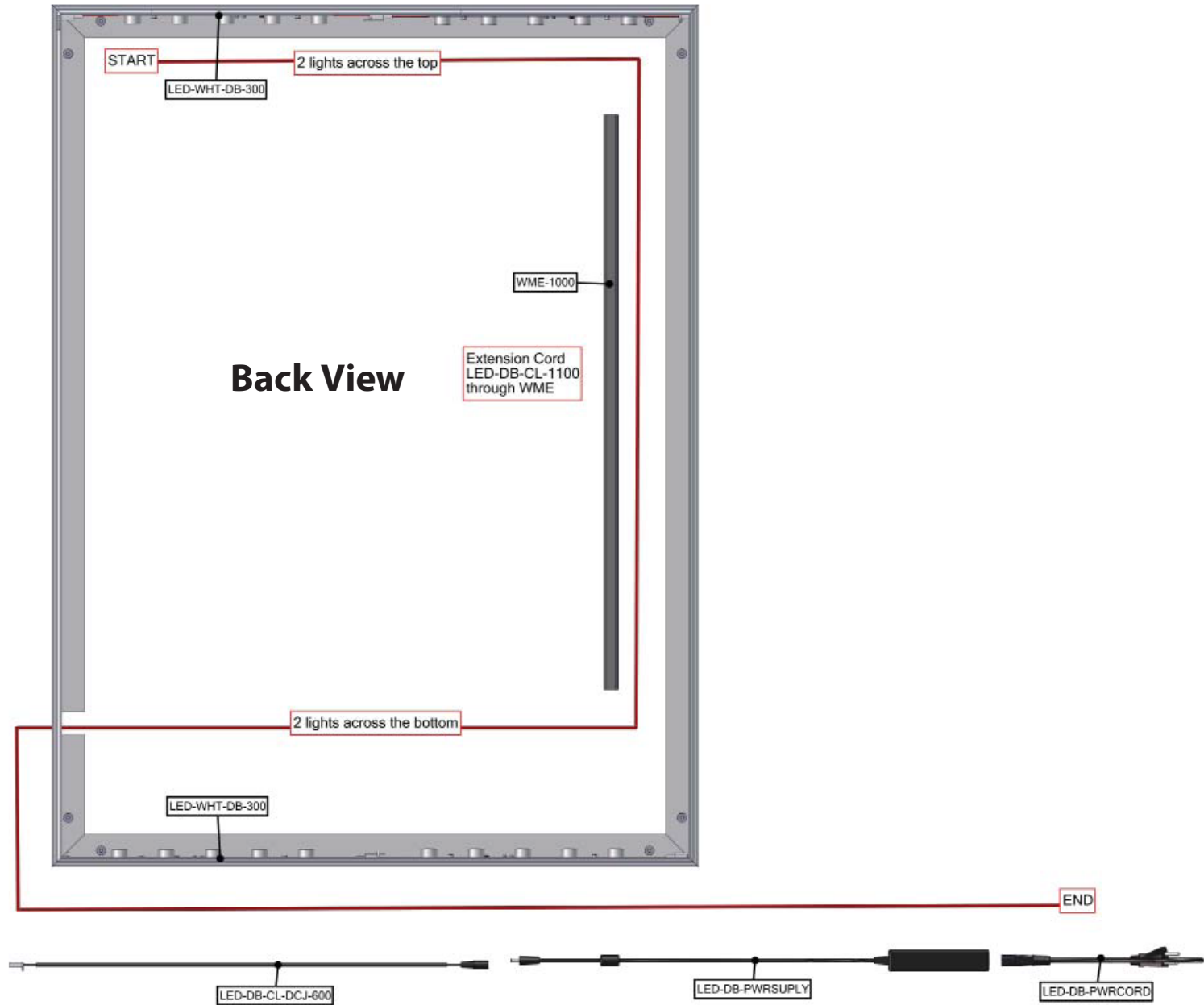

Connection Methods

Extrusion based structures use a number of different yet simple connection methods. Your kit will include one or more of the connection methods shown below. Steps within the Kit Assembly will reference a specific method for each connection point.

Connection Method 1: Cam Lock / Slide Lock

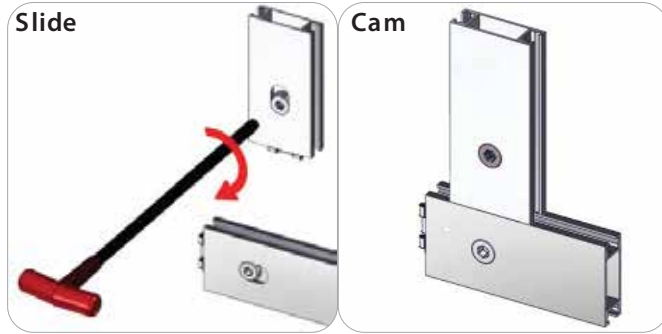

A cam lock equipped extrusion can lock to any cam lock channel. With the cam lock unlocked, set the teeth of the cam lock into the desired position on the cam lock channel. Using your allen key tool, carefully turn the lock clockwise to lock in place. Be sure to lock securely, but do not over tighten.

A slide lock equipped extrusion can also lock into any cam lock channel. When the slide lock is unlocked, pull back on the hex bolt head to retract the slide lock into the body of the extrusion. Slide locking procedure is the same as a cam lock.

Connection Method 2: IB2 / Corner Brackets

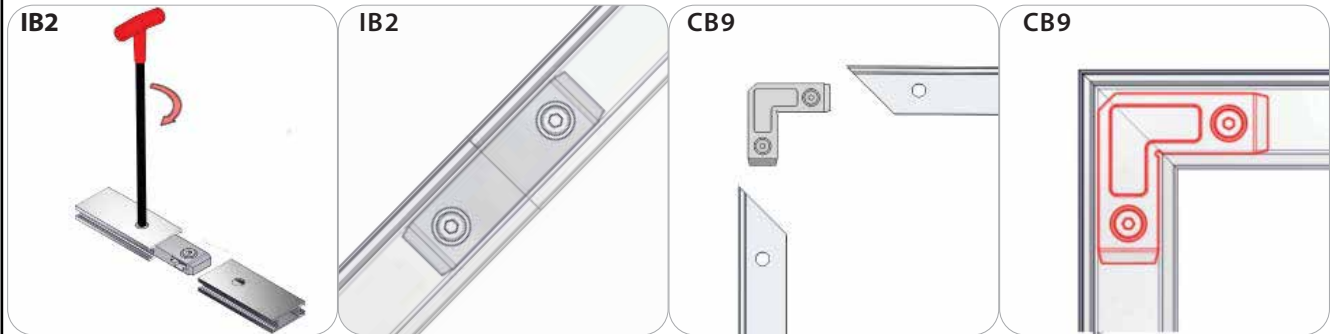

Press the hex bolt head in with your thumb and slide the extrusion and connector together so that the hex bolt head sits into the lock hole. Repeat with the second extrusion to the free end of the connector. Lock the extrusions together by turning carefully with the allen key tool. Be sure to lock securely, but do not over tighten.

Connection Method 3: SW-FOOT



An SW-FOOT assembly consists of two thumb screws, an LN100, and SW-FOOT baseplate. Start by loosening the thumb screws (it is best not to completely remove the screws). Slide the extrusion onto the LN100 by utilizing its back cam channel. When the extrusion rests on baseplate or ground (depending on application), tighten the thumb screws to lock in place. Do not over tighten.

Connection Method 4: Internal Lighting Setup

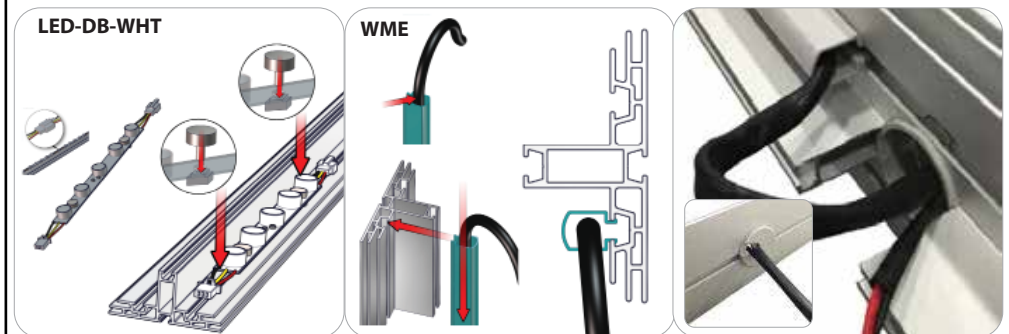

Be sure to fully assemble all frames before using the internal lighting components. With the thumbscrews loosened, place the light strips on the frame, then hand tighten them in series, male to female connections with extension cords. Do not over tighten the thumbscrews. Snap on the wire management extrusions with the power cord extensions in place. Reference the Internal Lighting Diagram for more details.

Kit Assembly

Step by Step

Step 1-

Gather the components necessary for assembling your light box frame. Assemble in the order the Exploded View instructs.

Refer to Connection Method 2 for additional information.

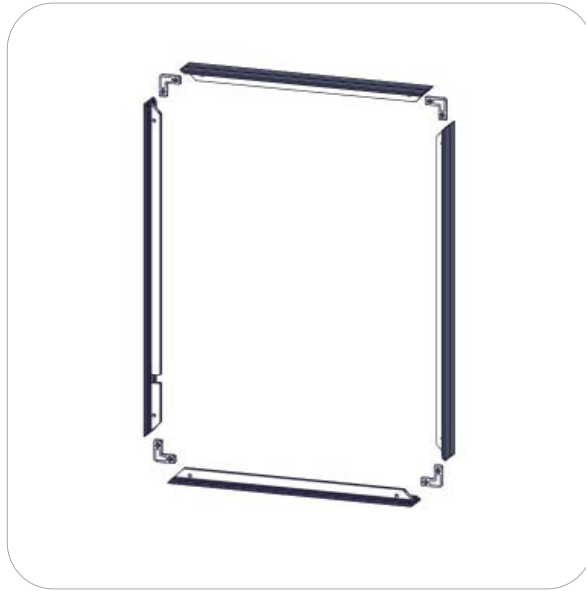

Step 2

Gather the components necessary for the Internal Lighting assembly to your light box. Assemble in the order the Exploded View and the Internal Lighting Setup Diagram instructs.

Refer to Connection Method 4 for additional information.



Step 3

Locate your silicone edge fabric panels. Push the silicone edges of the graphic panel into the primary grooves of the PHFC4 extrusion perimeter. Push the silicone edges of the opaque liner into the secondary grooves of the PHFC4 extrusion perimeter.

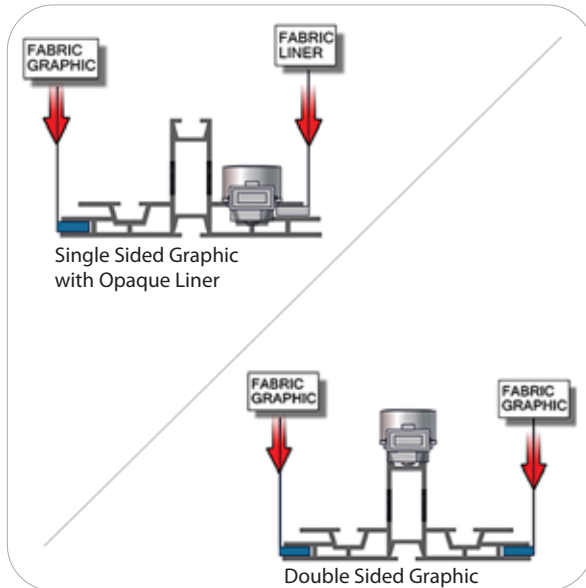
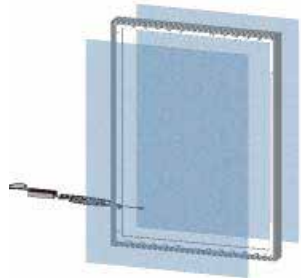

Step 4

Gather the components necessary for assembling your frame stabilizing bases. Assemble in the order the Exploded View instructs.

Refer to Connection Method 3 for additional information.

Setup Complete.

